

PROFILE

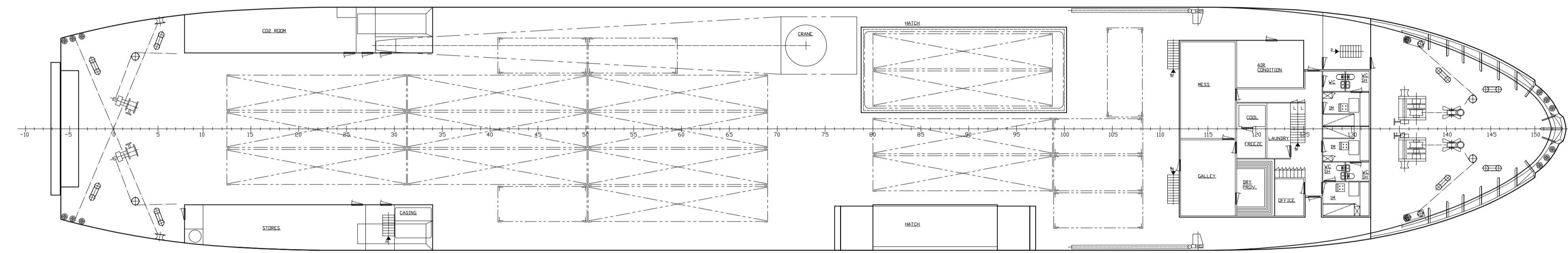

SHELTER DECK

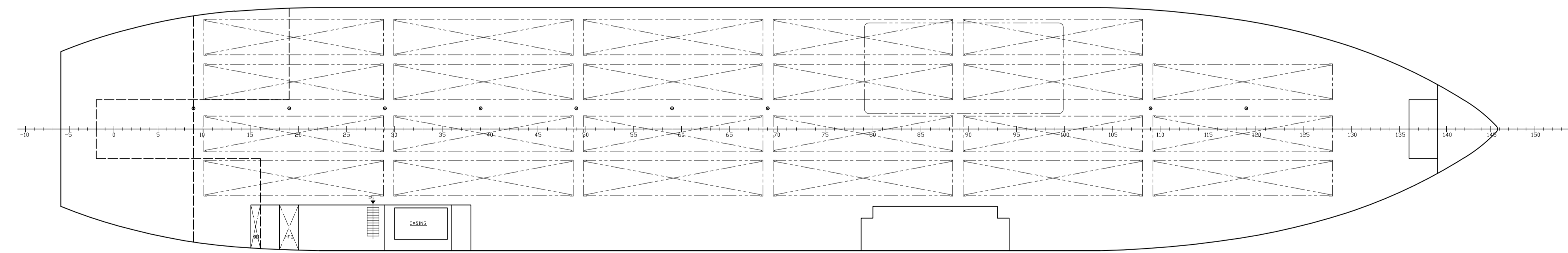

3rd DECK

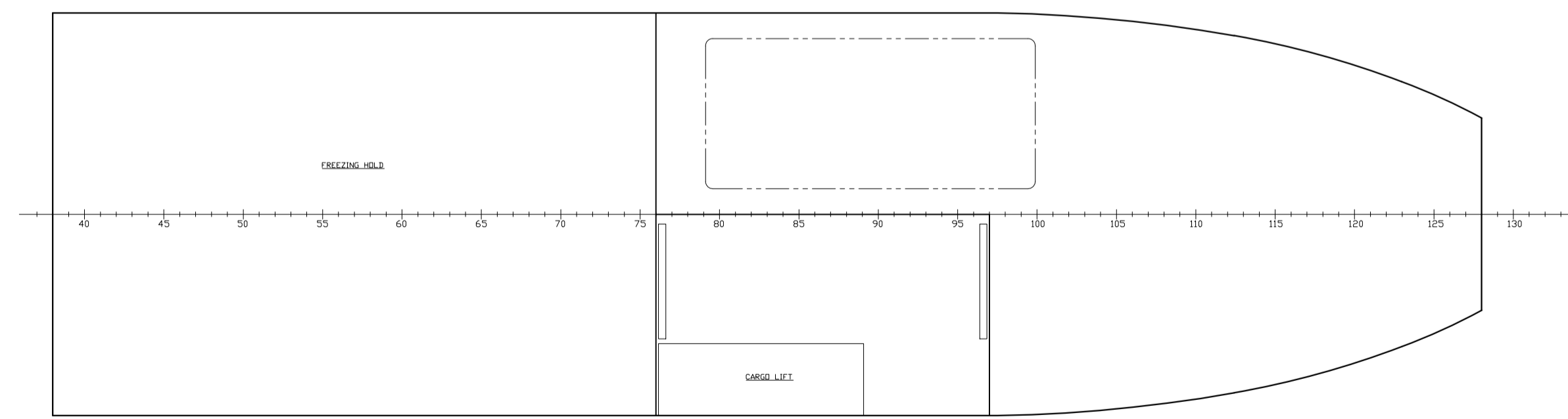

4th DECK

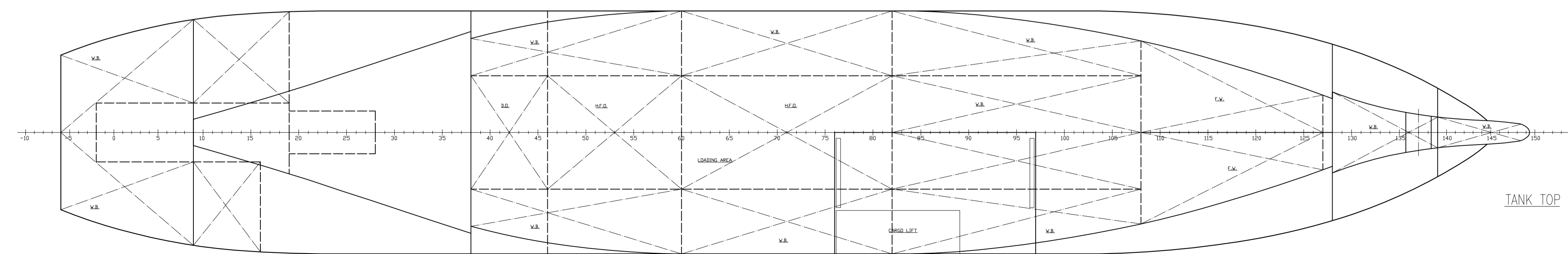

TANK TOP

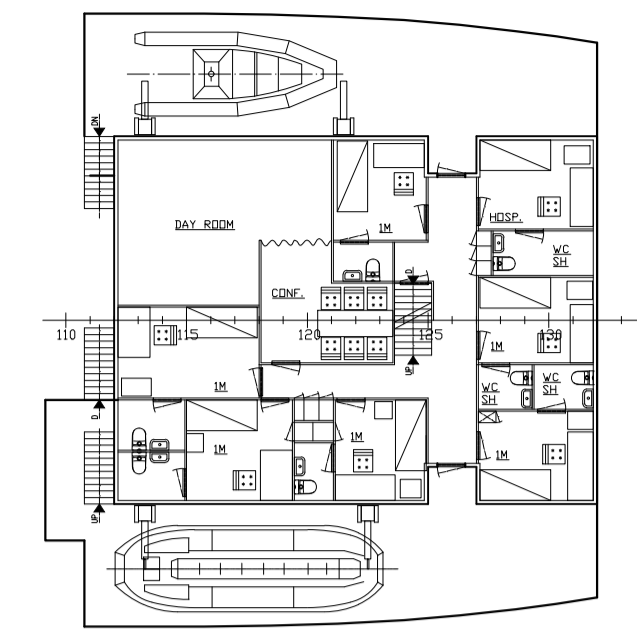

1. BRIDGE DECK

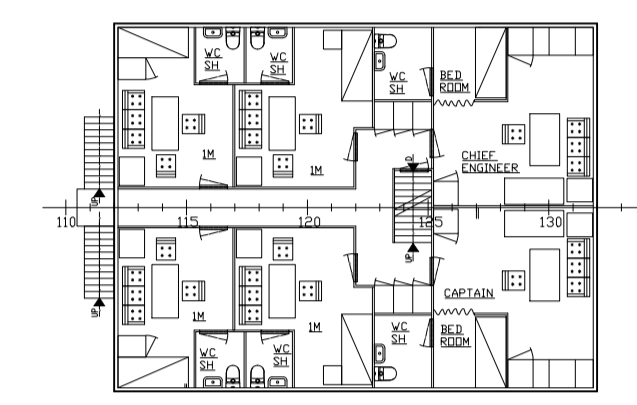

2. BRIDGE DECK

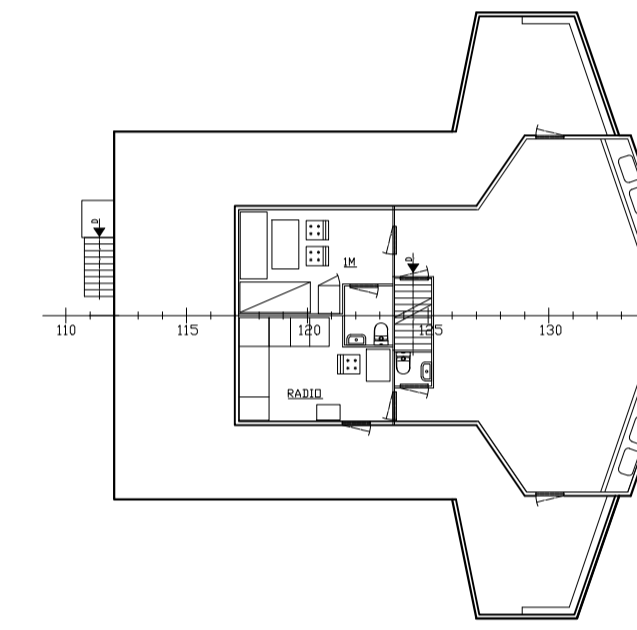

3. BRIDGE DECK

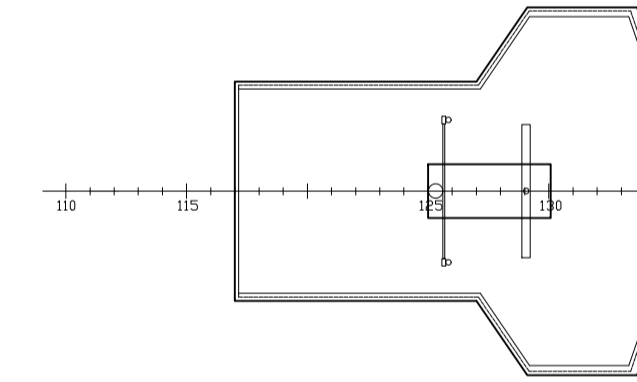

TOP OF WHEEL HOUSE

MAIN PARTICULARS

LENGTH OVER ALL	APPROX	102.20 m
LENGTH BETWEEN PP	APPROX	93.30 m
BREADTH MOULDED		16.50 m
DRAUGHT	APPROX	6.10 m

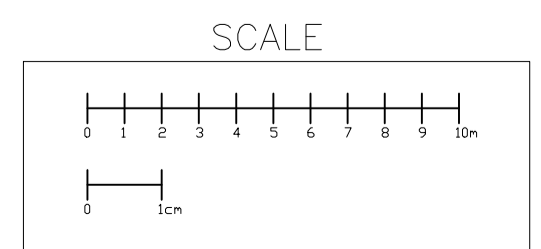

REV.	DATE	DESCRIPTION	MR	TT	MR
0	04.04.2024	FIRST ISSUE			

Norwest Ship Management AS
 P.O. box 104
 4236 Åkrehamn / Norway
 mob: +47 91 12 32 32
 mail: post@norwestship.no

Engineering: Ship Designers Poland - mail: shipdesignerspoland@gmail.com / mob: +48 665 77 04 05
 Vessel: LINK AURORA
 Project No: SD037

Drawn by:	MR	Date:	04.04.2024	Title:	
Chkd by:	TT	Date:	04.04.2024		
Apprd by:	MR	Date:	04.04.2024		

GENERAL ARRANGEMENT

Scale:	1:200	Format:	A0	Sheet:	1	Drawing No:	SD037-1200	Rev.:	0
--------	-------	---------	----	--------	---	-------------	------------	-------	---